



P3 PORTABLE HAND HELD GAUGE AND DIGITAL READOUT INSTRUCTION MANUAL

Publication number: D0300042001EN

Issue: A

Original Instructions



Declaration of Conformity

We, Edwards,
Innovation Drive,
Burgess Hill,
West Sussex,
RH15 9TW, UK

declare under our sole responsibility, as manufacturer and person within the EU authorised to assemble the technical file, that the product(s)

- P3 Gauge - D03000420

to which this declaration relates is in conformity with the following standard(s) or other normative document(s)

EN61326-1:2013 Electrical equipment for measurement, control and laboratory Use.
(Class B Emissions, EMC requirements. General requirements
Industrial Immunity)

and fulfils all the relevant provisions of

2014/30/EU Electromagnetic Compatibility (EMC) Directive
2011/65/EU Restriction of Certain Hazardous Substances (RoHS) Directive

Note: This declaration covers all product serial numbers from the date this Declaration was signed onwards.

Larry Marini, Senior Technical Manager

18.04.2017, Eastbourne

Date and Place

This product has been manufactured under a quality management system certified to ISO 9001:2008

This page intentionally blank.

Copyright notice

© Edwards Limited 2017. All rights reserved.

Trademark credits

Edwards and the Edwards logo are trademarks of Edwards Limited.

Contents

Safety	1
Pictogram definition	1
Description	2
Orientation	2
Delivery content	2
Product description	2
Measurement principle	3
Warm-up time	3
Accuracy	3
Dependency on gas type	3
Proper use	3
Improper use	3
Overview	4
Technical data	5
Installation	7
Installation notes	7
Vacuum connection	7
Electrical connection	7
Battery operation	7
Operation with external mains adaptor	8
USB interface	9
Operation	10
Short time pressure display/Auto-Off mode	10
Continuous pressure display/Cont mode	10
Pressure display with data logging	10
Short-term operation (Auto-Off mode)	11
Stored maximum pressure:	11
Stored minimum pressure:	11
Data Logger mode:	12
PC mode	12
Configuration	14
Logging rate	14
Adjustment	15
Adjustment on Atm	15
Adjustment on zero pressure	16
Pressure units	16
Maximum operation time	17
Gas correction factor	17

Maintenance and service	19
Error messages and malfunction	19
Storing and waste disposal	20
Storage	20
Disposal	20

List of Figures

General arrangement	4
Dimensions	5
Battery installation	8
Power supply and USB socket location	8

List of Tables

Error messages and malfunction	19
--------------------------------------	----

Safety

- Read and follow the instructions in this manual.
- Familiarise yourself regarding hazards, which could be caused by the product or arise in the system.
- Comply with all safety instructions and regulations for accident prevention.
- Check regularly that all safety requirements are being complied with.
- Take account of the ambient conditions when installing the P3 gauge. The protection class is IP 40, which means the unit is protected against penetration of foreign bodies.
- Adhere to the applicable regulations and take the necessary precautions for the process media used.
- Consider possible reactions between materials and process media.
- Consider possible reactions of the process media due to the heat generated by the product.
- Do not carry out any unauthorized conversions or modifications on the unit.
- Before starting work, find out whether any of the vacuum components are contaminated.
- Adhere to the relevant regulations and take the necessary precautions when handling contaminated parts.
- When returning the unit to Edwards, please enclose a declaration of contamination.
- Communicate the safety instructions to other users.

Pictogram definition

Important instructions relating to technical safety and safe operation are emphasised by symbols.



WARNING:

Warnings are given where failure to observe the instruction could result in injury or death to people.



CAUTION:

Cautions are given where failure to observe the instruction could result in damage to the equipment, associated equipment and process.



Note:

General information pointing to further information, respectively reference sections.

Description

Orientation

These operating instructions describe installation and operation of products with item number D03000420 and D03000421.

The item number can be found on the product label. Technical modifications are reserved without prior notification.

Delivery content



Product description	Item number	Contents
P3 gauge	D03000420	P3 gauge
		Protective cover
		Operating instructions P3 gauge
		AlMn block battery 9 V
P3 gauge accessory kit	D03000421	Protective case
		Windows™ software VacuGraph™ with online help function
		USB interface cable
		Power supply 15 V for mains voltage 100 - 240 V a.c., 50/60 Hz, including exchangeable AC plugs type EURO, US, UK and AUS
		AlMn block battery 9 V d.c.
		Operating instructions for power supply

Product description

The P3 compact vacuum gauge measures total pressure in the range 1200 to 5×10^{-4} mbar.

The unit is equipped with a Piezo/Pirani combination sensor and is temperature compensated.

Pressure is displayed continuously over the whole measurement range.

Due to the integrated data logger functionality it is possible to store up to 2000 measurements in the vacuum gauge. By means of the USB interface, stored measurement data can be transmitted to a PC or measurements recorded online on a PC.

Measurement principle

The P3 gauge is equipped with an internal piezo-resistive sensor for measuring rough vacuum. The sensor comprises a resistor bridge which is mounted on a thin diaphragm which is bent under the force of the applied pressure. As the diaphragm is bent, the bridge becomes unbalanced and this is a measure of the applied pressure.

For the fine vacuum range a Pirani sensor is also integrated, which uses the heat conduction of gases for measuring vacuum. In a bridge circuit the filament is heated to constant temperature, the necessary bridge voltage is a measure for total gas pressure.

Warm-up time

Pressure is displayed immediately after the unit is switched on. To take advantage of the maximum accuracy in fine vacuum range it can be appropriate to allow for stabilization time of 2 minutes, especially when extreme pressure changes have occurred.

Accuracy

Using two different physical sensor principles the P3 gauge provides high resolution over the whole range. The unit is factory adjusted. Through contamination, ageing or extreme climatic conditions the need for readjustment may arise.

Accuracy therefore may be reduced in the range below 10^{-2} mbar.

Dependency on gas type

Due to the Pirani sensor, measurements below 15 mbar are dependent on the composition and type of the gas being measured. The unit is adjusted for nitrogen and dry air. With He and CO deviations will be almost negligible below 0.5 mbar.

For other gas types a correction factor can be entered which affects measurements below 15 mbar and produces correct pressure readings below 0.5 mbar (see [Gas correction factor](#)).

Proper use

The P3 gauge serves exclusively to provide total pressure measurements in the range 1200 to 5×10^{-4} mbar. It may only be connected to components specifically provided for such purpose.

Improper use

The use for purposes not covered above is regarded as improper, in particular:

- The connection to components not allowed for in their operating instructions.
- The connection to components containing touchable, voltage carrying parts.

No liability or warranty will be accepted for claims arising from improper use.

The user bears the responsibility with respect to the used process media.

Overview

Figure 1 General arrangement

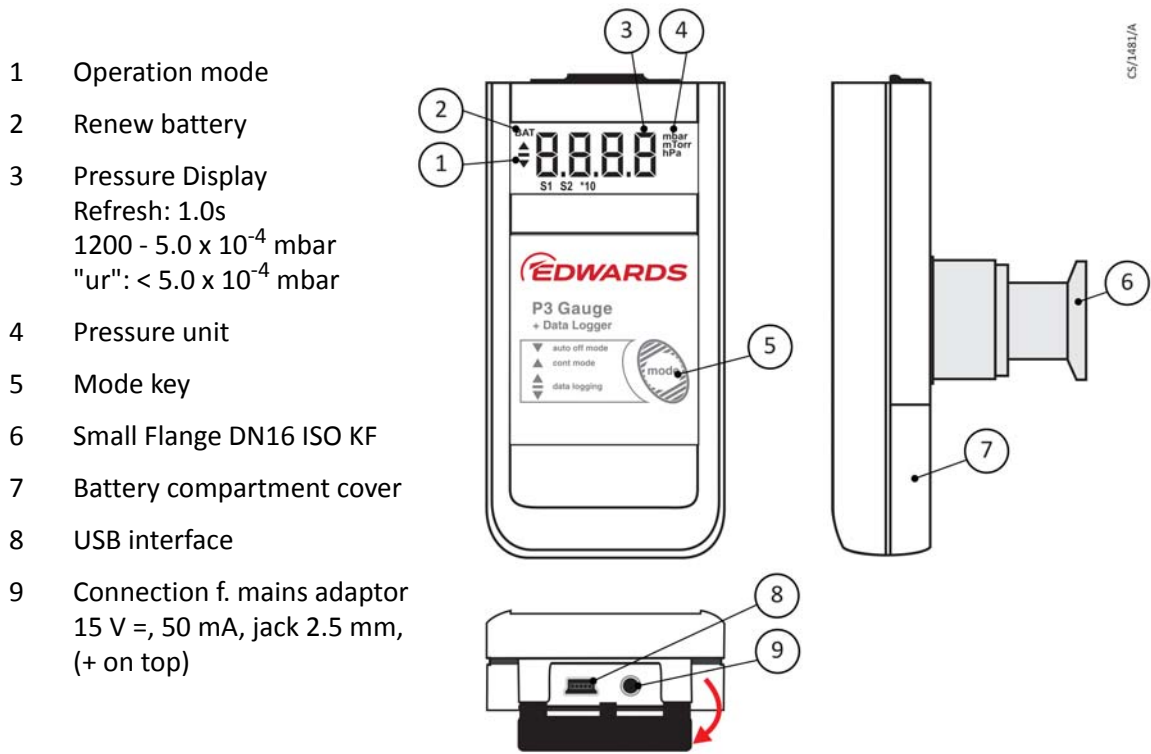

Technical data

Figure 2 Dimensions

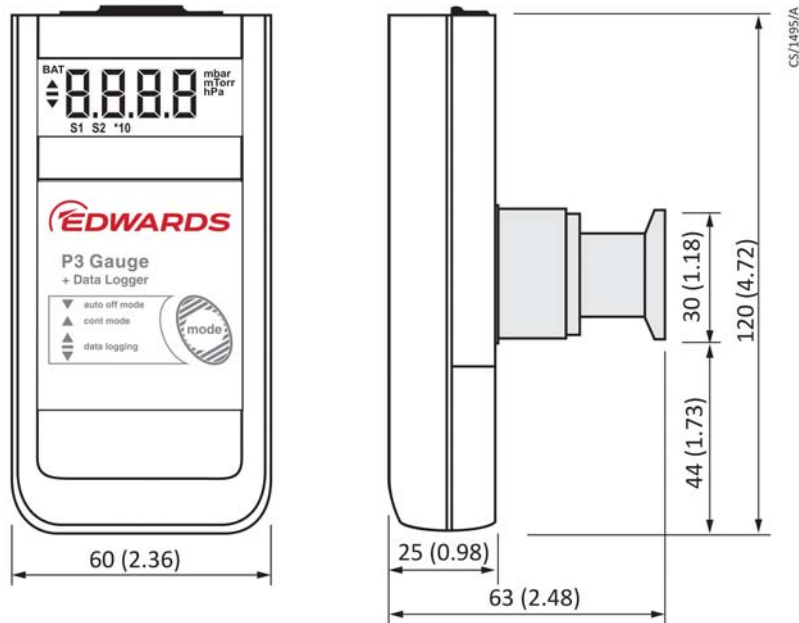

Measurement principle	piezo-resistive and heat conduction Pirani (gas type dependent)
Materials with vacuum	contact stainless steel 1.4307, gold, nickel, tungsten, glass, fluoroelastomer
Measuring range	1200 to 5.0×10^{-4} mbar (900 to 5.0×10^{-4} Torr) admissible overload 2 bara
Resolution	1200 to 1000 mbar: 1 mbar 1000 to 1 mbar: 0.1 mbar < 1 mbar: 2 digits mantissa, 1 decimal place
Accuracy	1200 to 10 mbar: 0.3% full scale (full scale end) 10 to 2.0×10^{-3} mbar: 10% (of reading) < 2.0×10^{-3} mbar: < factor 2 (of reading)
Measuring rate	1.0 seconds
Logging rate	1 to 6000 seconds
Operating temperature	+5 to +50 °C
Storage temperature	-20 to +60 °C
Power supply	9 V d.c. battery or 15 V d.c. external
Electrical connection	mini-jack 2.5 mm for plug-in power supply
Power consumption	approximately 110 mW (clocked)
Operation time	Li-battery: <100 h, 6LR61 Alkaline: < 40 h
Serial interface	Mini-USB, Type B, 5-pin, female, Virtual Comm Port protocol

Vacuum connection	Small flange DN16 ISO KF
Display	LCD 12 mm
Protection class	IP 40
Weight	230 grams (including battery)

Installation

Installation notes



WARNING:

Unauthorized modifications or conversions of the instrument are not allowed.

Installation location:	Indoor
For not fully air conditioned open buildings and operation rooms:	
Temperature:	+5 °C to +50 °C
Relative Humidity:	5 to 85%, non-condensing

Vacuum connection



WARNING:

Accidental or unintended opening of clamp elements under stress can lead to injuries due to parts flying around. KF flange connections with elastomer seals cannot withstand pressures above 1.5 bar. Process media thus can leak and possibly damage health.



CAUTION:

Dirt and damage, especially at the vacuum flange, have an adverse effect on the function of this vacuum component. Please take account of the necessary instructions with regard to cleanliness and damage prevention when using vacuum components.

- Remove the protective cover (is required again during maintenance work).
- Make vacuum connection via small flange DN16 ISO KF; it is recommended to have the vacuum vessel electrically grounded.
- Use metal clamps, that can be opened and closed with appropriate tools only (for example, strap retainer tension ring).
- Use sealing rings with a centering ring.

Electrical connection



WARNING:

When using the external mains adaptor, supplied with P3 gauge accessories kit, ensure that the mains supply is in accordance with the ratings on the mains adaptor.

Battery operation

Before operating the P3 gauge, a suitable battery or rechargeable battery must be inserted.

For this purpose pull the battery cover on the back of the unit downwards and insert the battery as shown on the pictures below. Close the cover again by pushing it upwards until it snaps into position.

Figure 3 Battery installation



Battery types:

- 9 V d.c. AlMn block battery type 6LR 61; lifetime maximum 40 hours
- 9 V d.c. lithium block battery; lifetime maximum 100 hours



Note:

Poor battery power is indicated by the "BAT" prompt in the upper left corner of the display. The device still can be used. Only when the battery is flat will the vacuum gauge switch off.

Rechargeable batteries have to be removed for charging. Please use suitable, commercially available chargers.

The sockets for the plug-in power supply and USB are located behind a protective rubber lid (see Figure 4).

To access the sockets please carefully open the lid and pull it out slightly.

Figure 4 Power supply and USB socket location

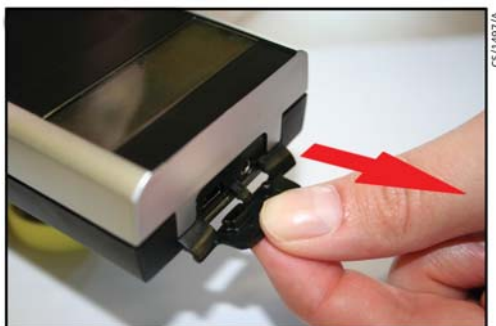

Operation with external mains adaptor

Alternatively to battery operation, the P3 gauge can be supplied by an external 15V plug-in mains adaptor (part of the P3 gauge accessories kit).

Before initial use connect the mains plug adaptor which is appropriate for your country. Ensure that the adaptor snaps in securely. Adaptors suitable for Europe, USA, UK and Australia are enclosed.

- The mains socket should be near the P3 gauge and should be accessible.

- The adaptor is for indoor use only
- The adaptor must be protected from splashing liquids
- The adaptor should not be allowed to overheat. The adaptor should not be covered up, situated near a heater or in direct sunlight. A small temperature rise of the adaptor during operation is however normal.
- The adaptor should be connected to mains sockets rated up to 16A maximum

The following figure shows the pin out of the 2.5mm jack plug.

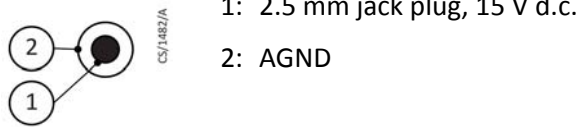

Note:

The battery can remain inside the P3 gauge when the mains adaptor is used.

For the recharging of batteries suitable, commercially available chargers have to be used.

USB interface

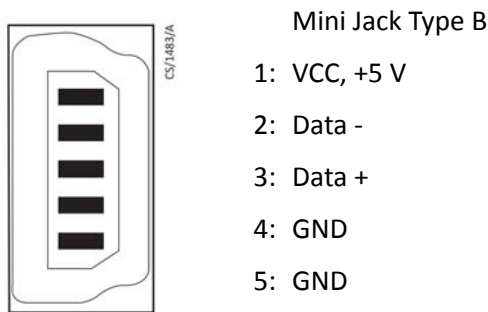

The USB interface can be connected to a PC. In combination with the VacuGraph™ Windows™ software, for instance, the data memory can be read out of the P3 gauge, transmit measurements online to the computer or configure the vacuum gauge.

Operation



WARNING:

Do not use the P3 gauge for safety critical applications. The P3 gauge is not intended to be fail safe.



WARNING:

Do not use the P3 gauge to measure the pressure of explosive or flammable gasses or mixtures. The gauge contains a heated filament which can operate at extremely high temperatures under fault conditions.

Short time pressure display/Auto-Off mode

Switch on the gauge by pressing the Mode key:



The actual pressure is displayed.

After 20 seconds the vacuum gauge is automatically switched off.

Continuous pressure display/Cont mode

Available only when data logger function is disabled.

Switch on the gauge by pressing the Mode key, then press Mode key again within 20 seconds:



The gauge is now operating in Cont mode and the actual pressure is displayed.

In Cont mode the instrument keeps operating continuously, until it is switched off manually or, after the maximum operation time has elapsed (see [Maximum operation time](#))

Switch off the gauge:



On further keystroke in Cont mode the unit returns to Auto-Off mode.

Pressure display with data logging

To operate the P3 gauge as a pressure display with data logger functionality, activate the logging function as described in [Logging rate](#).



Note:

Before a new data log is started the internal memory of the gauge must be cleared. This means that only one continuous measuring process can be saved at a time.

Short-term operation (Auto-Off mode)

Press Mode key:

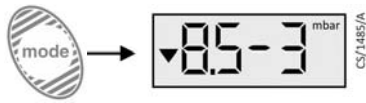

The actual pressure is displayed.

After 20 seconds the vacuum gauge is automatically switched off.

Stored maximum pressure:

Press Mode key again:

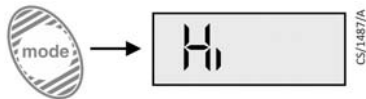

After two more seconds, the stored maximum pressure is displayed:



Without further keystroke: return to [Short-term operation \(Auto-Off mode\)](#) after 4 seconds.

Stored minimum pressure:

Press Mode key again:

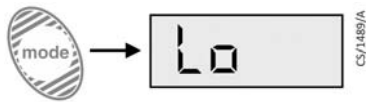

After two more seconds, the stored minimum pressure is displayed:



Without further keystroke: return to [Short-term operation \(Auto-Off mode\)](#) after 4 seconds.

Delete Memory:



"clr" flashes in the display.

On further keystroke the stored Min/Max values as well as the data memory are deleted.

Without further keystroke: return to [Short-term operation \(Auto-Off mode\)](#) after 4 seconds.

Data Logger mode:



The actual pressure is displayed.

The data memory is deleted. The P3 gauge is in Data Logger mode and from now on stores new extremal pressure values and, if applicable, up to 2000 measurements with the preset logging rate (see [Logging rate](#)).

The maximum time span for data recording arises from the capacity of the gauge's internal memory and the selected logging rate, for example:

Logging rate 1 second → approximately 33 minutes

Logging rate 10 minutes → approximately 13 days 21 hours

For data storage a battery independent memory IC is used.



Note:

The stored minimum and maximum values are lost when the battery is exchanged.

Data logging is stopped if no further memory is available, when the vacuum gauge is switched off or when it is connected to a PC via USB (see [PC mode](#)).

In the Data Logger Mode the P3 gauge keeps operating continuously until it is switched off manually or, after the maximum operation time has elapsed (see [Maximum operation time](#)).

Switch off the vacuum gauge during data logging:

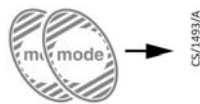

Press Mode key twice: return to Auto-Off mode.

PC mode

For data transmission the P3 gauge can be connected to a PC via a USB interface.

The VacuGraph™ Windows™ Software (part of the P3 gauge accessories kit) supports the recording of measurements as well as the readout of the P3 gauge data memory.

Measurements are plotted as a diagram and can be exported as a text file for further analysis.



Note:

The separately saved values of minimum and maximum pressure cannot be transmitted to the PC.

Parameter settings such as logging rate, choice of pressure units or gas correction factor can easily be changed by means of the VacuGraph™ software.

The P3 gauge is switched into PC mode as soon as a cable connection with a free PC USB port is established:



The P3 gauge is now ready for bidirectional data transmission

**Note:**

Before a new data log is started the internal memory of the gauge must be cleared. This means that only one continuous measuring process can be saved at a time.

When a measurement is started using the Vacugraph™ Windows™ software, the P3 gauge will display the actual pressure after each data query sent by the PC:



The display is switched off automatically after 20 seconds if no further data queries are sent by the PC.

**Note:**

The injection of electrical noise from the PC over the USB cable can give rise to a shift of the measurement signal of the order one digit. The effect can be reduced by having the instrument's flange connected to ground.

After the USB cable is disconnected the P3 gauge switches into Auto-Off mode.

Configuration

To switch the P3 gauge into Configuration mode:

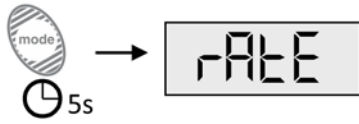

With the instrument switched off hold the Mode key pressed for approximately 5 seconds, until the display shows "rAtE".

Logging rate

To set the logging rate of the P3 gauge and thereby activate the data logging functionality, switch the unit into Configuration mode. For this the instrument must be switched off. Hold the Mode key pressed then, until the display shows "rAtE":

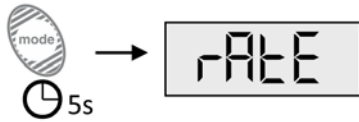

After additional 5 seconds, the current rate setting for internal data logging is displayed and can now be adjusted by means of the Mode key:

off "oFF" / High low "HiLo" / 1.0 second "1s" / 2.0 seconds "2s" / 10 seconds "10s" / 1 minute "1min" / 10 minutes "10min" / triggered "trig".



"off": data logging is disabled.



"HiLo" means that only minimum and maximum pressure is stored. These values can be displayed but cannot be transmitted to a PC.



Save measurements every 1.0 seconds.



"trig" means that new measurements are saved only if the new value differs more than 2 digits from the one that was stored last (for example 2.3 → 2.5). Data volume is reduced this way and optimum memory utilisation is achieved.

When data logging is active minimum and maximum pressure are recorded simultaneously.



Note:

Using the Vacugraph™ Windows™ software and the USB interface, USB interface the user can set logging rates between 1.0 second and 6000 seconds arbitrarily. The logging rate which was set last this way is also available as an option in the P3 gauge display and is shown after "trig".

Without further keystroke the vacuum gauge is switched into Auto-Off mode after 5 seconds. The last settings are saved.

Adjustment

The instrument is factory adjusted. Through use under different climatic conditions, through extreme temperature changes, ageing or contamination readjustment can become necessary.

To adjust the P3 gauge, switch the unit into Configuration mode. For this the instrument must be switched off. Hold the Mode key pressed then, until the display shows "rAtE" and then press the Mode key several times until the display shows "CAL".



Adjustment on Atm



Note:

Consider altitude and use a trusted reference pressure.

Adjustment on atmosphere pressure is possible only if the displayed actual pressure is above 800 mbar. Otherwise adjustment is denied and the error message "Err" displayed (see Maintenance and service, error messages and malfunction).

After 5 more seconds the display shows:



Press Mode key, the actual atmosphere pressure is displayed:



If "mTorr" is selected as pressure unit, the display will automatically change to "Torr" during the adjustment.



Using the Mode key, the reference pressure can be adjusted: every keystroke changes the displayed value for another 1 mbar alternating upwards and downwards.

After 5 seconds without further keystroke adjustment is performed:



During the adjustment procedure the display shows "CALI".

Afterwards, the unit switches to Auto-Off mode.

Adjustment on zero pressure



Note:

For adjustment on zero pressure, the actual pressure inside the sensor has to be less than 1×10^{-4} mbar.

The pressure reading must be less than 4×10^{-2} mbar, otherwise adjustment is denied and the error message "Err" displayed (see Maintenance and service, error messages and malfunction).

Switch the unit to Configuration mode like described above and press Mode key several times, until "CAL" is displayed.

After 5 more seconds the display shows:



After 5 more seconds the display shows:



Press Mode key for adjustment. During the adjustment procedure the display shows "CALI".

When the adjustment procedure is finished, the unit switches to Auto-Off mode.

Pressure units

To set the displayed pressure unit, switch the P3 gauge into Configuration mode. For this the instrument must be switched off. Hold the Mode key pressed then, until the display shows "rAtE" and then press the Mode key several times until the display shows "unit".



After 5 more seconds the current unit setting is displayed:



Using the Mode key "mbar", "Torr", "mTorr" or "hPa" can now be selected.

Without further keystroke, the unit switches to Auto-Off mode after approximately 5 seconds. The last settings are saved.

Maximum operation time

When operating continuously in Cont mode or Data Logger mode the unit stays switched on, until a selected maximum operation time has elapsed. To set this maximum operation time, after which the unit is automatically turned off anyway, switch the P3 gauge into Configuration mode. Therefore, the instrument must be switched off. Hold the Mode key pressed then, until the display shows "rAtE" and then press the Mode key several times until the display shows "hour".



After 5 more seconds the current setting of maximum operation time is displayed:



Using the Mode key you can now select a timespan from 1 hour to 24 hours or cont (no switch off).

Without further keystroke, the unit switches to Auto-Off mode after approximately 5 seconds. The last settings are saved.



Note:

If a maximum operation time other than "Cont" is set, the gauge will be switched off anyway after the selected time span has elapsed. Any active data logging will be stopped.



Note:

Using the Vacugraph™ Windows™ software and the USB interface, the user can set a maximum operating time between 1 and 99 hours.

Gas correction factor

The output signal of the Pirani sensor inside the P3 gauge and therefore the pressure reading of the gauge below 15 mbar depend on the type and composition of the gas being measured. The device is adjusted for nitrogen and dry air; for He and CO the deviation can be neglected below 0.5 mbar. For other gases a correction factor can be set which affects pressure reading below 15 mbar and produces correct readings below 0.5 mbar. The measurements of the Pirani sensor are hereby multiplied with the correction factor.

Correction factor Pirani:

Gas	Correction factor
Ar	1.6
CO ₂	0.89
He	1.0
Ne	1.4

Gas	Correction factor
CO	1.0
N ₂	1.0
Kr	2.4

To adjust the gas correction factor, switch the unit into Configuration mode. For this the instrument must be switched off. Hold the Mode key pressed then, until the display shows "rAtE" and then press the Mode key several times until the display shows "corr".



After 5 more seconds the current factor setting is displayed:

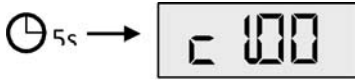

The setting range is 0.20 to 8.00.



The value can now be incremented by means of the Mode key. If you hold the key pressed the value counts up automatically to 8.00 and then restarts at 0.20.

Without further keystroke, the unit switches to Auto-Off mode after approximately 5 seconds. The last setting of the gas correction factor is saved.



Note:

If a correction factor different from 1.00 is set, symbol "S1" is shown at the lower boundary of the display.



Maintenance and service



WARNING:

Contaminated parts can cause personal injuries. Inform yourself regarding possible contamination before you start working. Be sure to follow the relevant instructions and take care of necessary protective measures.

The unit requires no maintenance. External dirt and soiling can be removed by a damp cloth. Should a defect or damage occur on the P3 gauge, please send the instrument to Edwards for repair.



CAUTION:

The unit is not customer serviceable.



Note:

Malfunctions of the unit, which are caused by contamination or breaking of the filament are not covered by warranty.

Error messages and malfunction

Table 1 Error messages and malfunction

Problem	Possible cause	Correction
high measurement error	contamination, ageing, extreme temperature, maladjustment	readjustment
display shows "or"	pressure over range	(pressure > 1200 mbar)
display shows "ur"	pressure under range	(pressure < 5×10^{-4} mbar)
error message "Err"	adjustment performed at incorrect pressure	displayed pressure must be >800 mbar when performing. atmosphere adjustment, < 4×10^{-2} mbar when performing. zero adjustment
	measurement error out of adjustment range	send unit for repair
error message "Err1"	defective sensor	send unit for repair

Storing and waste disposal

Storage



CAUTION:

Cover the vacuum ports of the product with protective caps or grease free aluminium foil. Do not exceed the admissible storage temperature range.

Inappropriate storage leads to an increase in the desorption rate and/or may result in mechanical damage of the product.

Disposal

Dispose of the P3 gauge and any accessories safely and in accordance with all local and national safety and environmental requirements.

Alternatively, the P3 gauge and /or accessories may be able to be recycled; contact Edwards or supplier for advice (also see below).

The P3 gauge and/or accessories is within the scope of the European Directive on Waste and Electronic Equipment, 2012/19/EU. Edwards offers customers a recycling service for the product/cables/associated gauges at the end of the product's life. Contact Edwards for advice on how to return the P3 gauge and/or accessories for recycling.

This page has been intentionally left blank.

This page has been intentionally left blank.

Return of Edwards Equipment - Procedure

INTRODUCTION

Before returning your equipment, you must warn Edwards if substances you used (and produced) in the equipment can be hazardous. This information is fundamental to the safety of our Service Centre employees and will determine the procedures employed to service your equipment.

Complete the Declaration (HS2) and send it to Edwards before you dispatch the equipment. It is important to note that this declaration is for Edwards internal use only, and has no relationship to local, national or international transportation safety or environmental requirements. As the person offering the equipment for shipment, it is your responsibility to ensure compliance with applicable laws.

GUIDELINES

- Equipment is '**uncontaminated**' if it has not been used, or if it has only been used with substances that are not hazardous. Your equipment is '**contaminated**' if it has been used with any substances classified as hazardous under the UN Globally Harmonised System on the classification and labelling of chemicals (GHS), EU Regulation No 1272/2008 on classification, labelling and packaging (CLP) or US Occupational Safety and Health regulations (29CFR1910.1200, Hazard Communication).
- If your equipment has been used with radioactive substances, biological or infectious agents, mercury, polychlorinated biphenyls (PCB's), dioxins or sodium azide, you must decontaminate it before you return it to Edwards. You must send independent proof of decontamination (for example a certificate of analysis) to Edwards with the Declaration (HS2). Phone Edwards for advice.
- If your equipment is contaminated, you must either:
 - Remove all traces of contamination (to the satisfaction of laws governing the transportation of dangerous/hazardous substances).
 - Or, properly classify the hazard, mark, manifest and ship the equipment in accordance with applicable laws governing the shipment of hazardous materials.

Note: Some contaminated equipment may not be suitable for airfreight.

PROCEDURE

1. Contact Edwards and obtain a Return Authorisation Number* for your equipment.
2. Complete the Return of Edwards Equipment - Declaration (HS2).
3. If the equipment is contaminated, you must contact your transporter to ensure that you properly classify the hazard, mark, manifest and ship the equipment, in accordance with applicable laws governing the shipment of contaminated/hazardous materials. As the person offering the equipment for shipment, it is your responsibility to ensure compliance with applicable law. **Note: Equipment contaminated with some hazardous materials, such as semiconductor by-products, may not be suitable for airfreight - contact your transporter for advice.**
4. Remove all traces of hazardous gases: pass an inert gas through the equipment and any accessories that will be returned to Edwards. Where possible, drain all fluids and lubricants from the equipment and its accessories.
5. Seal up all of the equipment's inlets and outlets (including those where accessories were attached) with blanking flanges or, for uncontaminated product, with heavy gauge tape.
6. Seal equipment in a thick polythene/polyethylene bag or sheet.
7. If the equipment is large, strap the equipment and its accessories to a wooden pallet. If the equipment is too small to be strapped to a pallet, pack it in a suitable strong box.
8. E-mail via scan, fax or post a copy of the original with signature of the Declaration (HS2) to Edwards. The Declaration must arrive before the equipment.
9. Give a copy of the Declaration (HS2) to the transporter. You must tell your transporter if the equipment is contaminated.
10. Seal the original Declaration in a suitable envelope: attach the envelope securely to the outside of the equipment package, in a clear weatherproof bag.

WRITE YOUR RETURN AUTHORISATION NUMBER* CLEARLY ON THE OUTSIDE OF THE ENVELOPE OR ON THE OUTSIDE OF THE EQUIPMENT PACKAGE.

** not applicable in Japan*

Return of Edwards Equipment - Declaration

Return Authorisation Number: _____

You must:

- Know about all of the substances which have been used and produced in the equipment before you complete this Declaration
- Read the Return of Edwards Equipment - Procedure (HS1) before you complete this Declaration
- Contact Edwards to obtain a Return Authorisation Number and to obtain advice if you have any questions
- Send this form to Edwards before you return your equipment as per the procedure in HS1

SECTION 1: EQUIPMENT

Manufacturer's Product Name _____
 Manufacturer's Part Number _____
 Manufacturer's Serial Number _____

Has the equipment been used, tested or operated?
 YES, Used or operated Go to Section 2
 YES, Tested, but not connected to any process or
 production equipment, and only exposed to Nitrogen,
 Helium or Air Go to Section 4
 NO Go to Section 4

IF APPLICABLE:

Tool Identification Number _____
 Tool Manufacturer/OEM _____
 Tool Model _____
 Process _____
 Installed Date _____ De-installed Date _____
 Part Number of Replacement Equipment _____
 Serial Number of Replacement Equipment _____
 Pump datalog attached? YES NO
 (Edwards Internal Use Only)

SECTION 2: SUBSTANCES IN CONTACT WITH THE EQUIPMENT

Are any substances used or produced in the equipment:

- Radioactive, biological or infectious agents, mercury, poly chlorinated biphenyls (PCBs), dioxins or sodium azide? (if YES, see Note 1) YES NO
- Hazardous to human health and safety? YES NO

Note 1: Edwards will not accept delivery of any equipment that is contaminated with radioactive substances, biological/infectious agents, mercury, PCB's, dioxins or sodium azide, unless you:

- Decontaminate the equipment
- Provide proof of decontamination

YOU MUST CONTACT EDWARDS FOR ADVICE BEFORE YOU RETURN SUCH EQUIPMENT

SECTION 3: LIST OF SUBSTANCES IN CONTACT WITH THE EQUIPMENT

Substance name	Chemical Symbol	Precautions required (for example, use protective gloves, etc.)	Action required after a spill, leak or exposure

SECTION 4: RETURN INFORMATION

Reason for return and symptoms of malfunction: _____

For how many hours has the product run? _____ Do you wish to purchase a full Failure Analysis report? YES NO

If you have a warranty claim:

- who did you buy the equipment from? _____
- give the supplier's invoice number _____

SECTION 5: DECLARATION

Print your name: _____ Print your job title: _____

Print your organisation: _____

Print your address: _____

Telephone number: _____ Date of equipment delivery: _____

I have made reasonable enquiry and I have supplied accurate information in this Declaration. I have not withheld any information, and I have followed the Return of Edwards Equipment - Procedure (HS1).

Signed: _____ Date: _____

Note: Please print out this form, sign it and return the signed form as hard copy.

This page has been intentionally left blank.

